

PART
NAME

UTILIBOX (STYLE K)

PART
No.

CU-1951

REV.
DATE

MATERIAL: HIGH-IMPACT ABS
(FLAMMABILITY RATING OF UL94-HB)
FINISH: BLACK TEXTURED

ALL DIMENSIONS HAVE ± 0.015 TOLERANCE.

BOX FEATURES PRESS-FIT COVER AND
THREE MOLDED-IN PROTRUDING WIRE/CABLE ENTRY POINTS.

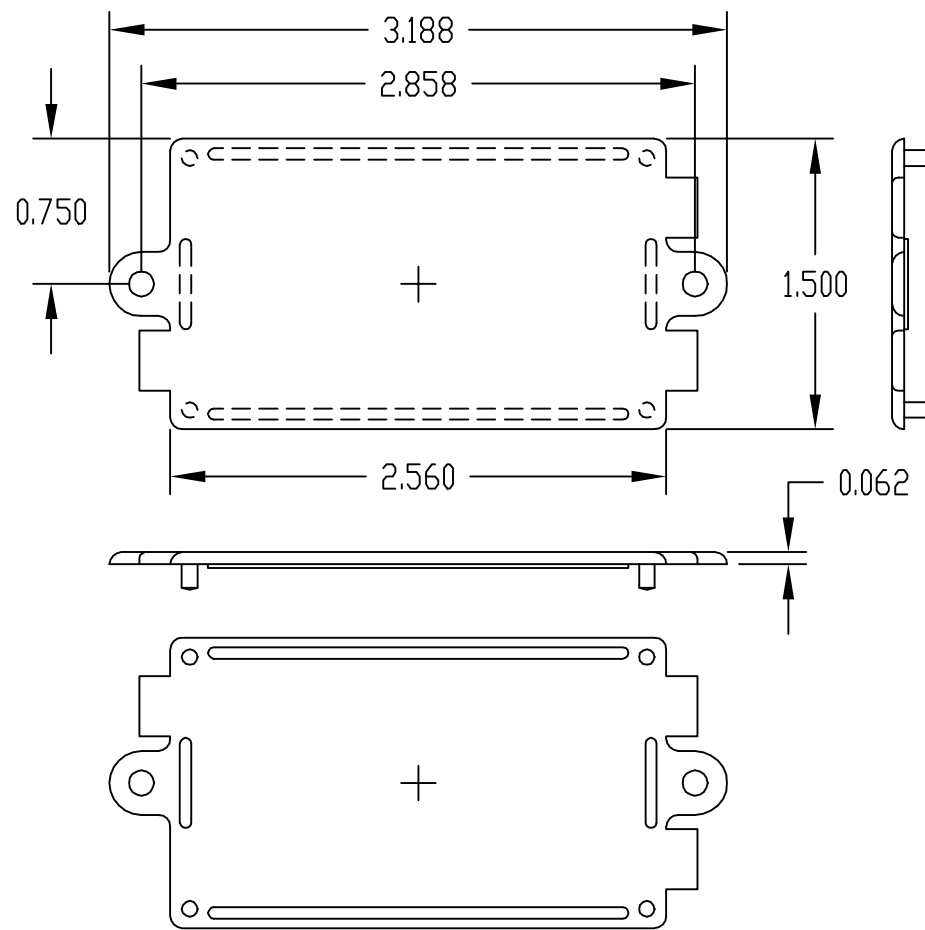
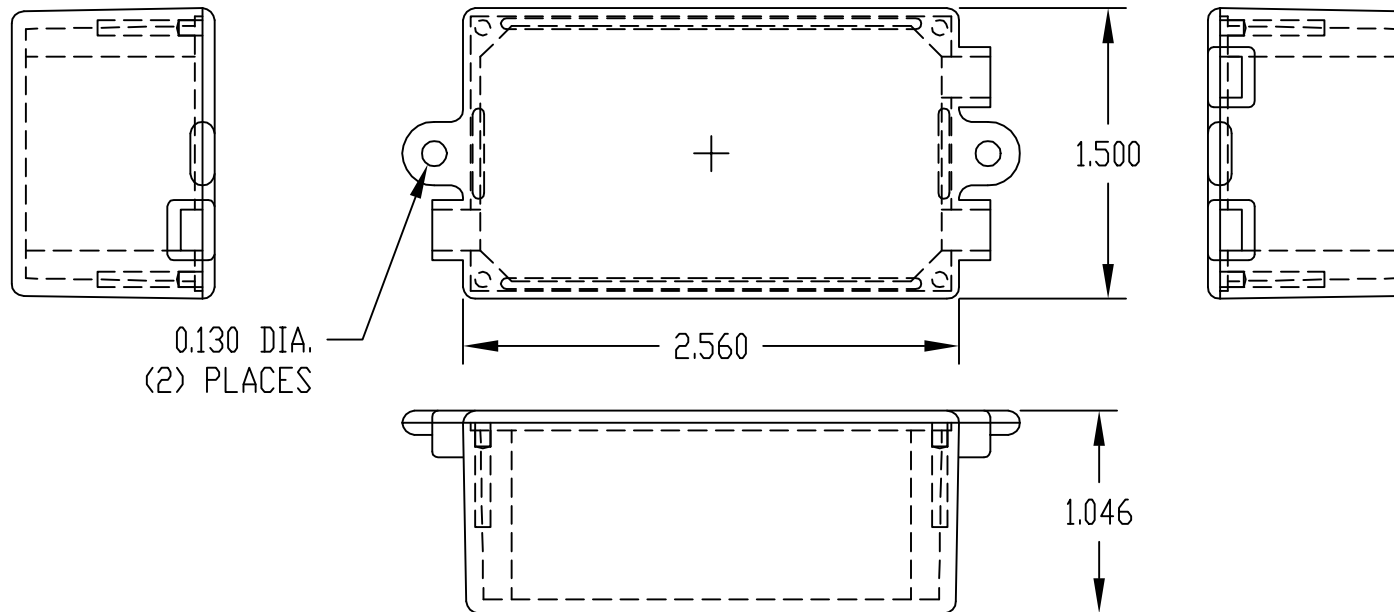

COVER

